

Hoffmann II

External Fixation System

Operative Technique

- Modular System for
- Long Bones
 - Pelvis

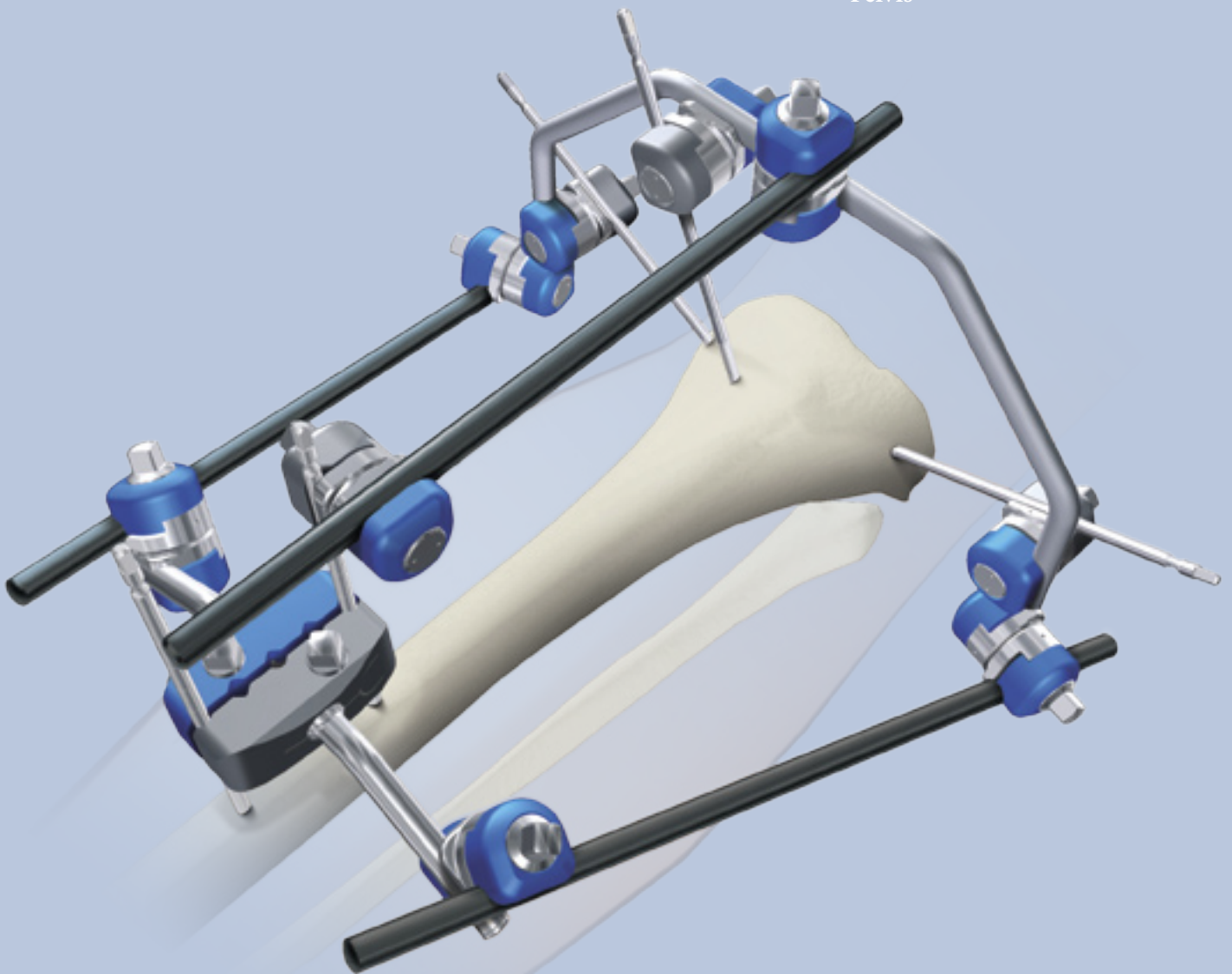

Introduction

In 1938, Raoul Hoffmann, a surgeon from Geneva, Switzerland, designed a revolutionary External Fixation System. The basic features of this system were its modular design and the ability to reduce fractures or to make post operative corrections to the alignment of fragments in three planes with the frame in situ.

The Hoffmann II^{®1} has built upon these principles, and today is the gold standard in modular external fixation. Certainly, the Hoffmann II[®] family of products is unmatched in its ease-of-use, versatility, and patient comfort.

You will find in the following pages common frame building techniques for the Hoffmann II[®] System.

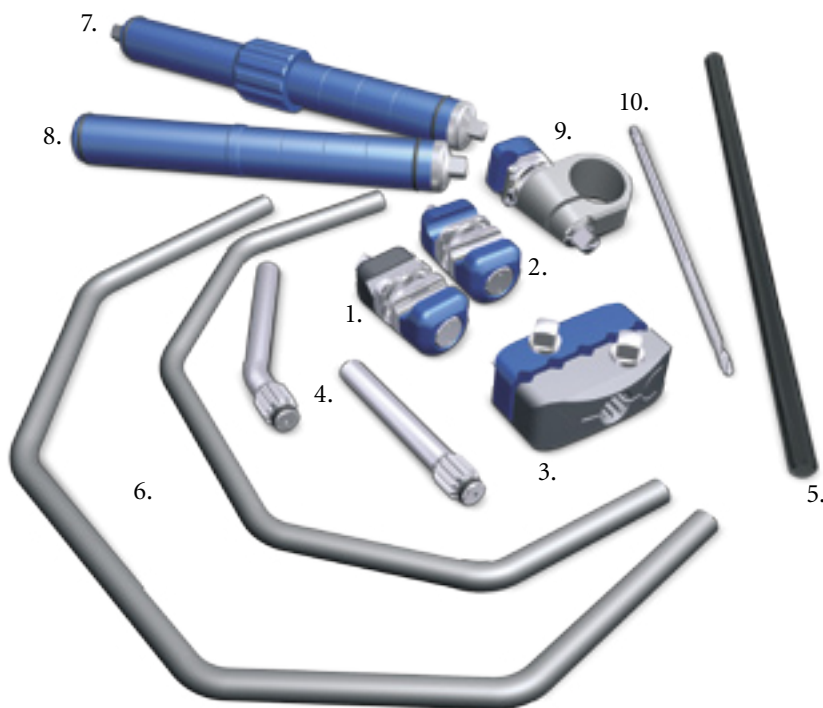

1. Pin to Rod Coupling
2. Rod to Rod Coupling
3. 5-Hole Pin Clamp
4. Straight Post / 30° Angled Post
5. ø8mm Connecting Rods
6. Semi-Circular Aluminum Connecting Rods
7. Dynamization Tube
8. Compression/Distraction Tube
9. Tube to Rod Coupling
10. Apex[®] Self-Drilling Pins

¹ Hoffmann II[®] Design Surgeons

Dr. Gernot Asche,
Andy Burgess M.D.,
Prof. Franz Burny,
Mr. Charles M. Court-Brown,
Prof. Erkki O. Karaharju,
Loren Latta Ph.D.,
Prof. David Seligson M.D.,
Dr. Gregory Zych M.D.

Relative Indications & Contraindications

Relative Indications

Due to its versatility, the Hoffmann II® System is indicated for complete and temporary fracture fixation for Tibia, Femur, Pelvis, and Humerus fractures. It is particularly suited for the following indications:

- Open Fractures or Severe Soft-Tissue Injuries
- Peri-Articular Fractures
- Intra-Articular Fractures where a joint bridging frame can be used
- Temporary Fracture Stabilization leading to definitive treatment
- Poly-Trauma Patients
- Other indications including Osteotomies and Arthrodesis

Relative Contraindications

If uncertainty exists with regard to the anatomic location of the neurovascular structures due to post-traumatic destruction, the device should be used with extreme caution. Under these circumstances, the pins should be inserted under direct vision.

The presence of extensive internal fracture fixation devices

Pre-emptive medical condition

Bone Pathology

Operative Technique

Frame Building Guidelines

The guidelines given here will help you build frames which have been proven to provide stability for sustained fracture reduction and elasticity for dynamic osteosynthesis. By using these simple biomechanical principles, you can build a frame suited to the indication at hand.

Pin clamps are designed to build a variety of frames. When using 2 half-pins within a clamp, use the hole positions furthest apart if the anatomy and soft tissues allow. This pin position is the most stable pin to clamp construct.

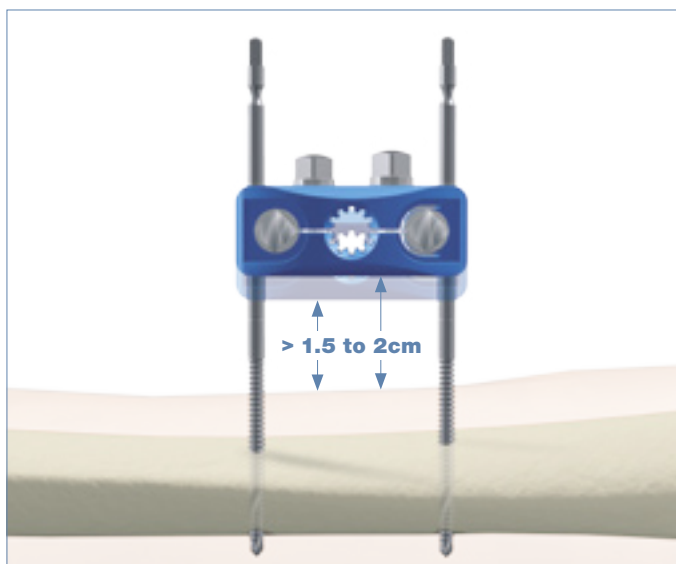
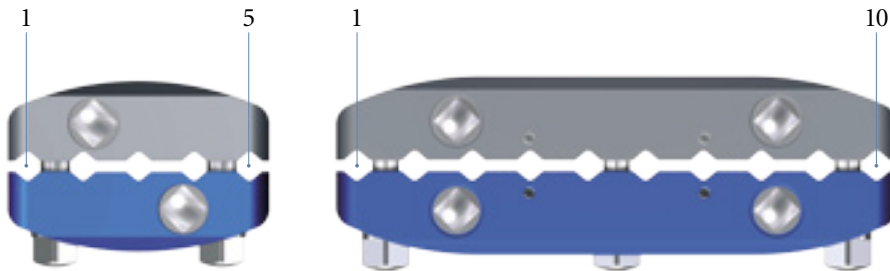

Pin clamps and couplings should be placed approximately 1.5 to 2.0 centimeters away from the soft tissue to allow for post-operative swelling and proper pin-site care.

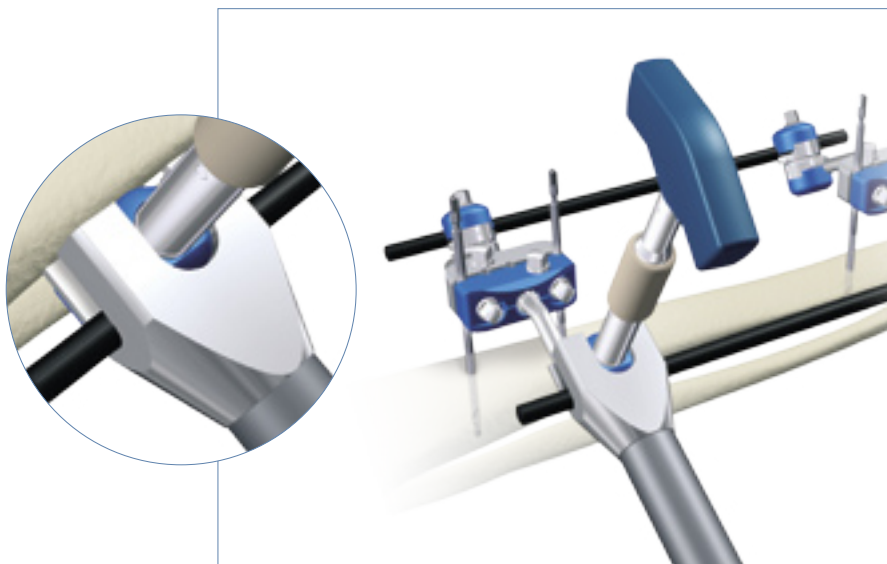

When tightening the clamps and couplings, it is important to apply sufficient torque to fully tighten the frame. It is also important to provide sufficient counter torque so that the tightening of the frame does not damage the pin/bone interface or disturb the fracture site. Make sure to hold onto the clamp or coupling to be tightened. This can be facilitated by using the Stabilization/Reduction Wrench as shown here.

Operative Technique

Pin Insertion Guidelines

Four types of half-pins are offered in the system: Blunt/Self-Tapping Half-Pins, Blunt/Cancellous Half-Pins, Self-Drilling/Self-Tapping Half-Pins, and Self-Drilling Transfixing Pins. Pre-drilling is necessary when using blunt pins. It is optional to pre-drill when using self-drilling pins.

- Use a $\varnothing 3.2\text{mm}$ drill to pre-drill a $\varnothing 4\text{mm}$ pin
- Use a $\varnothing 4.0\text{mm}$ drill to pre-drill a $\varnothing 5\text{mm}$ pin
- Use a $\varnothing 4.5\text{mm}$ drill to pre-drill a $\varnothing 6\text{mm}$ pin or a Cancellous Half-Pin

It is important to have a stable pin to bone interface. To ensure this, make sure to obtain bi-cortical purchase with the pin.



Self-Drilling Pin



Blunt Pin



Cancellous Pin



Transfixing Pin



Due to the high versatility of the Hoffmann II® System, an unlimited number of frame configurations can be constructed, thus providing surgeons the ease of use to treat a variety of indications.

This Technical Guide provides step by step surgical techniques for four standard frame assemblies. These assemblies can then be adapted to other indications.

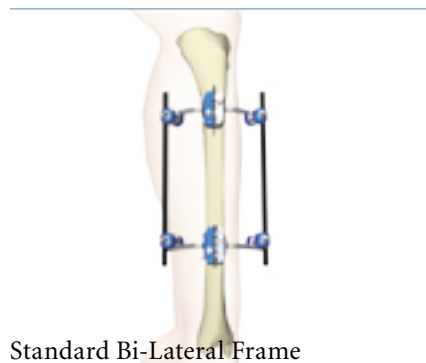

Standard Bi-Lateral Frame



Proximal Tibia Frame

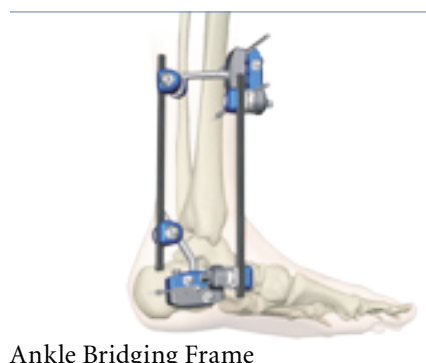

Ankle Bridging Frame

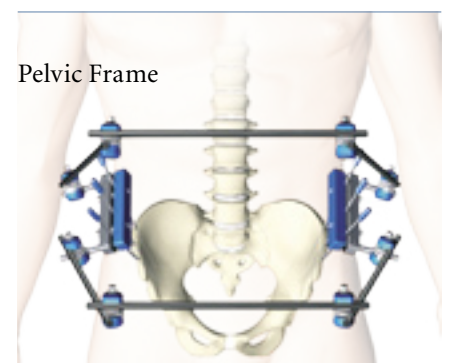

Pelvic Frame

Operative Technique

Tibia Shaft Frame

Half-Pin Insertion Guidelines

The safe zone of the tibia shaft is the medial side. For maximum bi-cortical bone purchase and patient comfort, it is suggested to insert pins 15° to 20° anterior to the coronal plane.



Step 1

The surgical technique utilizes a limited open approach for half-pin insertion. Make an incision at least 2cm proximal to the fracture site.

Using soft-tissue protection, manually insert the first half-pin making sure to obtain bi-cortical purchase.

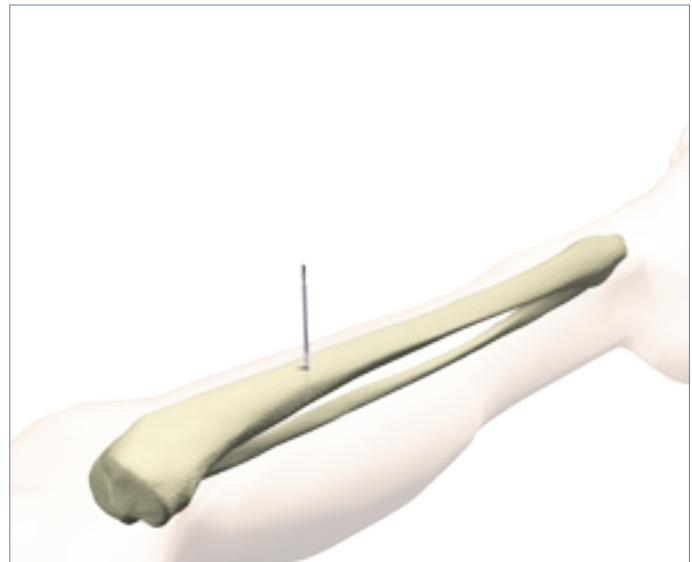

Step 2

Insert a second half-pin parallel to the first half-pin so that it will correspond to one of the holes in the clamp.

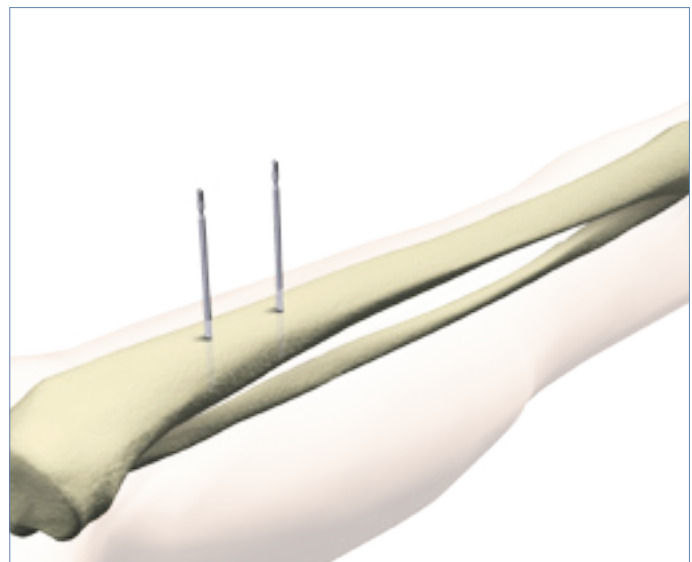

Operative Technique

Tibia Shaft Frame

Step 3

Position the 5-Hole Pin Clamps approximately 1.5 to 2.0 centimeters away from the skin. Tighten Bolts A to secure the clamps to the half-pins. Repeat Steps 1, 2 and 3 for the distal half-pin groups making an incision at least 2cm distal to the fracture site.

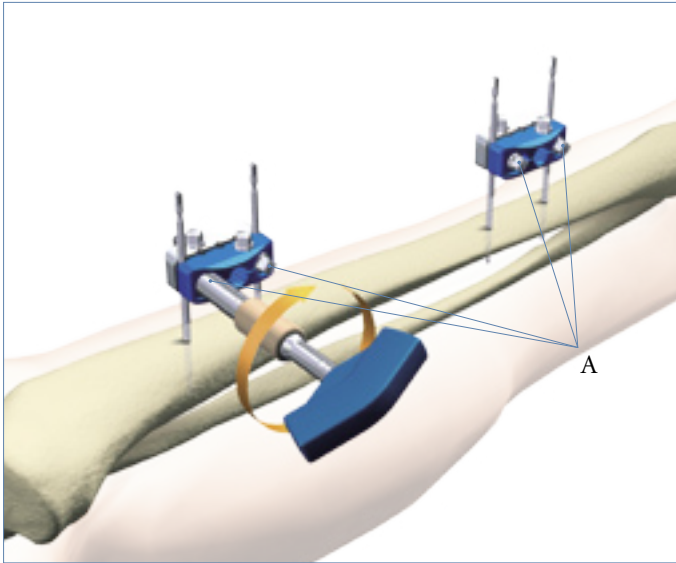

Step 4

Assemble two Hoffmann II® Posts with each of the 5-Hole Pin Clamps. Tighten Bolts B to secure the posts.

Note:

The posts may be placed in twelve different positions. It is also possible to use straight or 90° posts. These post options give flexibility to build frame configurations as needed.

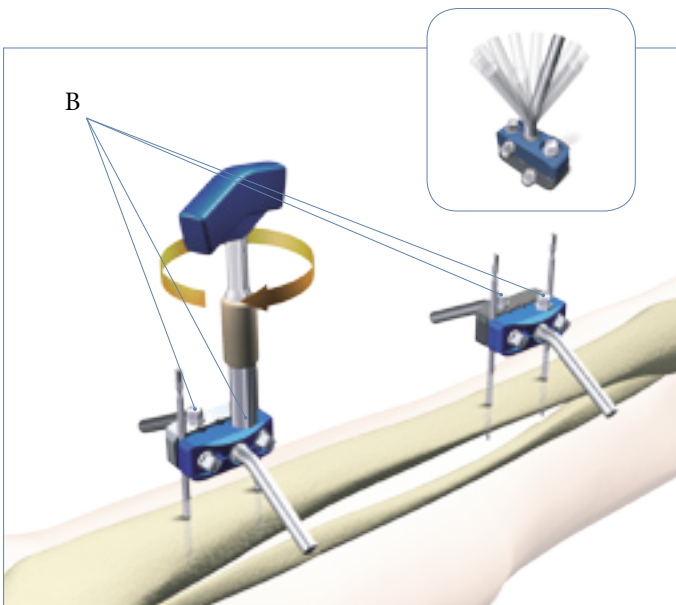

Step 5

Connect four Rod to Rod Couplings to the posts and ø8mm Connecting Rods aligning the rods to the long axis of the tibia. This will connect the two 5-Hole Pin Clamps together. Unrestricted multi-planar motion of the components allows for the manipulation of the fracture fragments with the fixator in place.

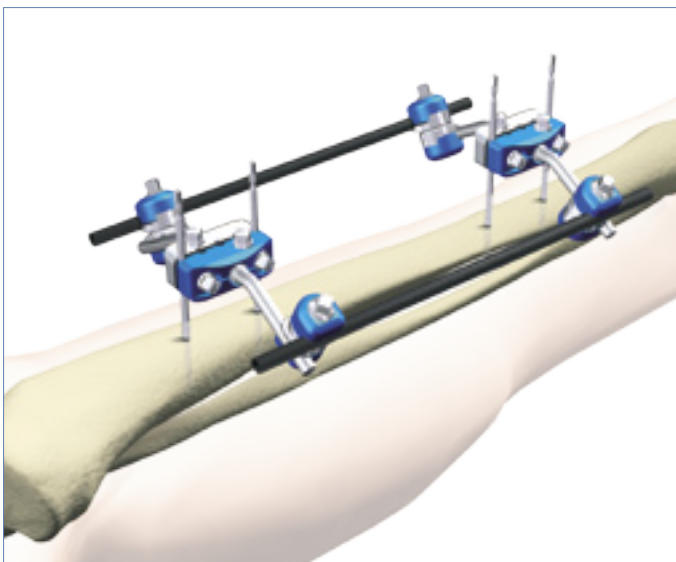

Operative Technique

Tibia Shaft Frame

Step 6

After final adjustments and satisfactory alignment have been restored, tighten Bolts C on the Rod to Rod Couplings. Also, ensure that all of the bolts of the frame are securely tightened.

For proper alignment, check the final reduction with x-ray.

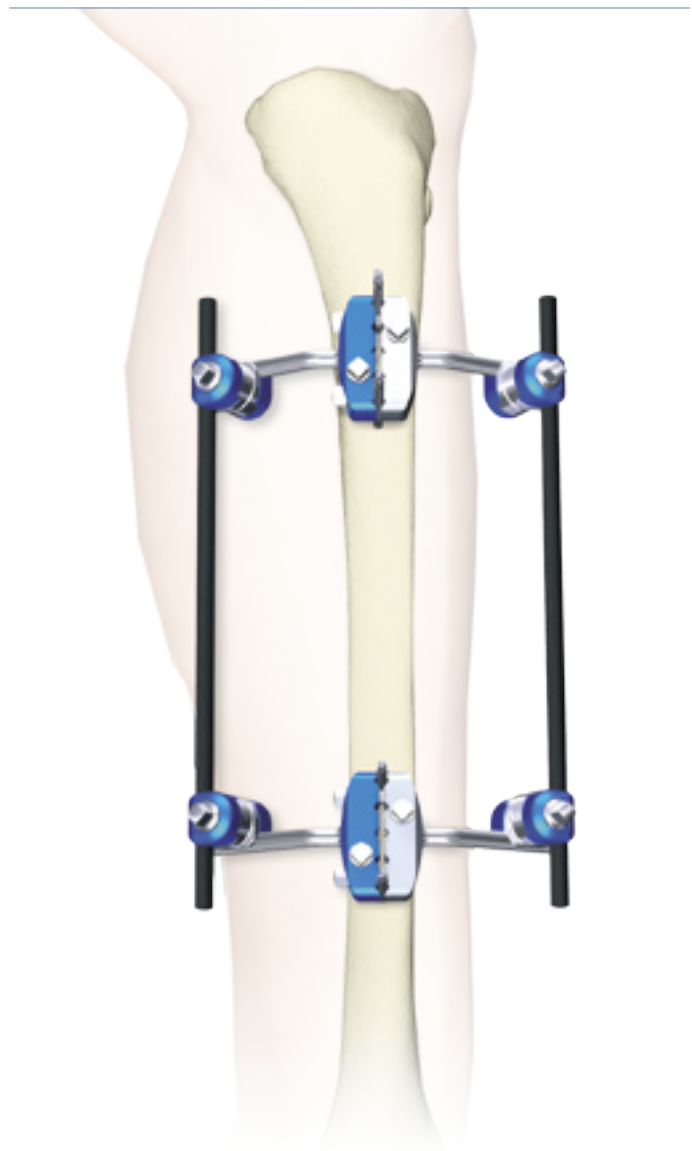
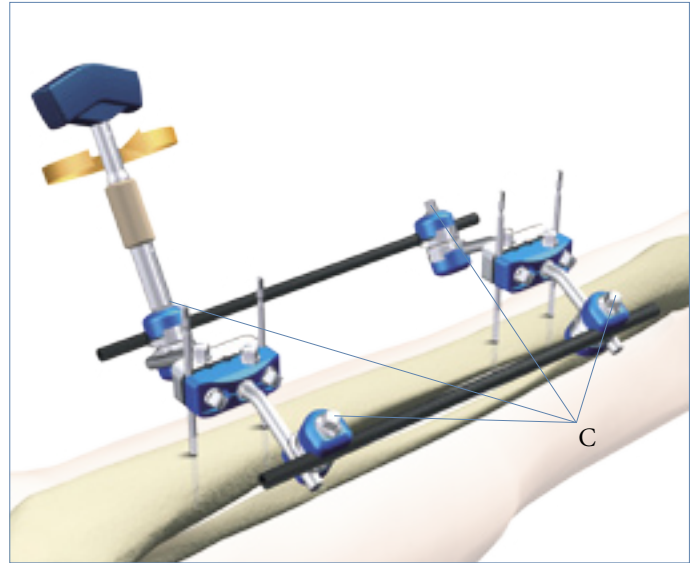

Operative Technique

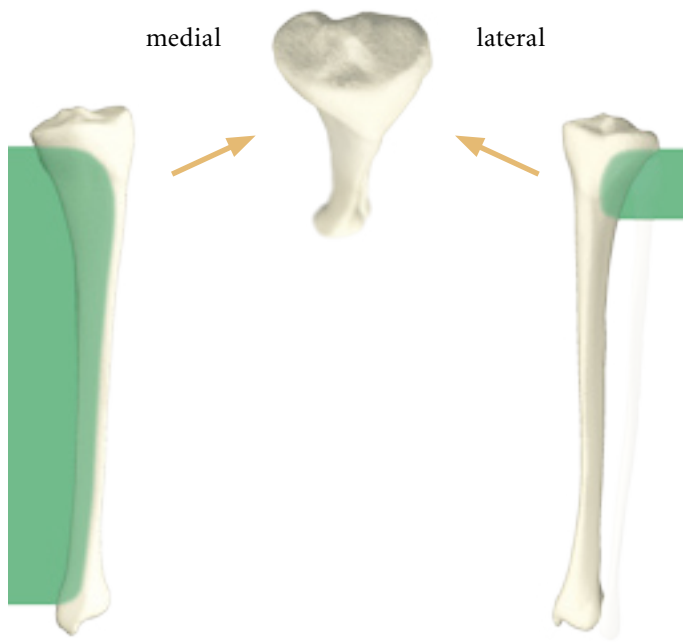

Tibia Plateau Fracture

Half-Pin Insertion Guidelines

For this frame, 3 half-pins are inserted into the metaphyseal region of the proximal tibia at least 1.5 centimeters distal to the plateau under x-ray control. Also, 2 half-pins are inserted antero-medially in the shaft of the tibia, approximately 90° to the long axis of the bone. The safe zones are illustrated here.

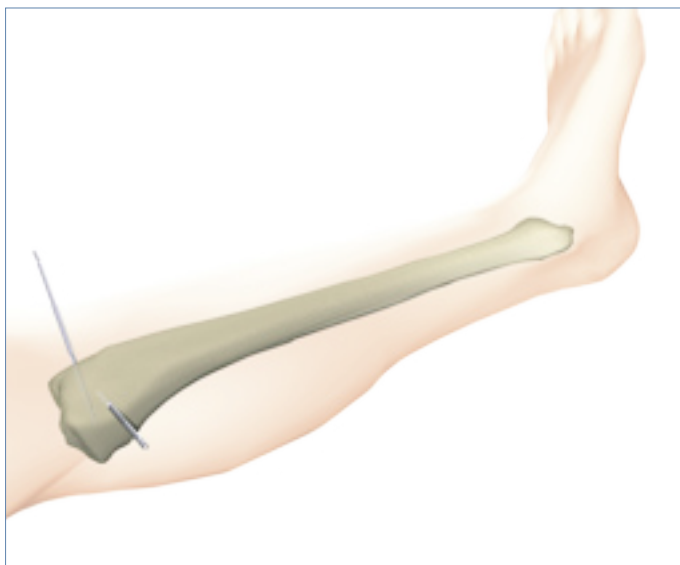

Step 1

Using soft-tissue protection, manually insert the medial and lateral half-pins in the metaphyseal region of the tibia. Ensure that the half-pins do not compromise the joint capsule.

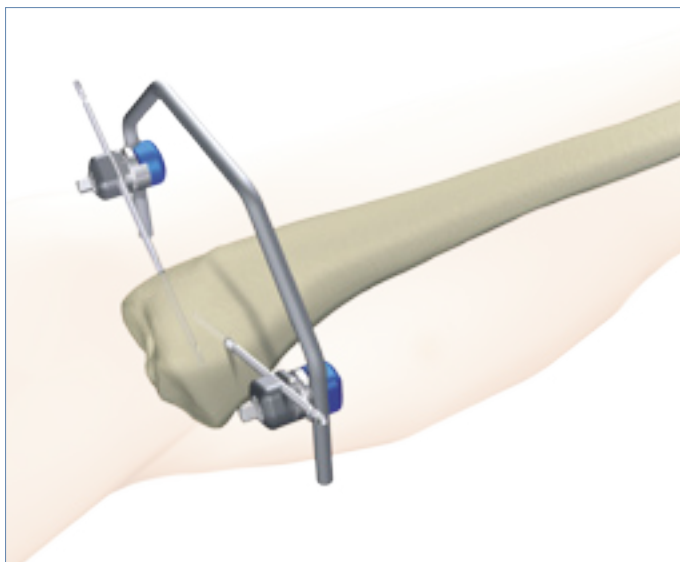

Step 2

Connect a Pin to Rod Coupling to each half-pin, and connect the couplings to a Curved Rod.

Operative Technique

Tibia Plateau Fracture

Step 3

Attach an Inverted Pin to Rod Coupling to the antero-medial aspect of the Curved Rod. Use this coupling as a guide for placing the antero-medial half-pin.

Note:

In this frame, an Inverted Pin to Rod Coupling is chosen due to its ease-of-use. A standard Pin to Rod Coupling may also be used if desired.

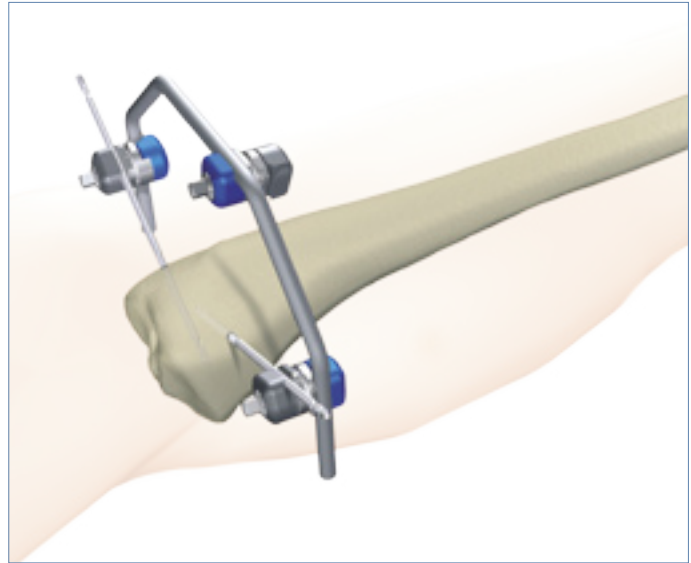

Step 4

Using soft-tissue protection, manually insert the half-pin. Then, tighten the Pin to Rod Couplings with Bolt A in order to secure the Curved Rod to the half-pins.

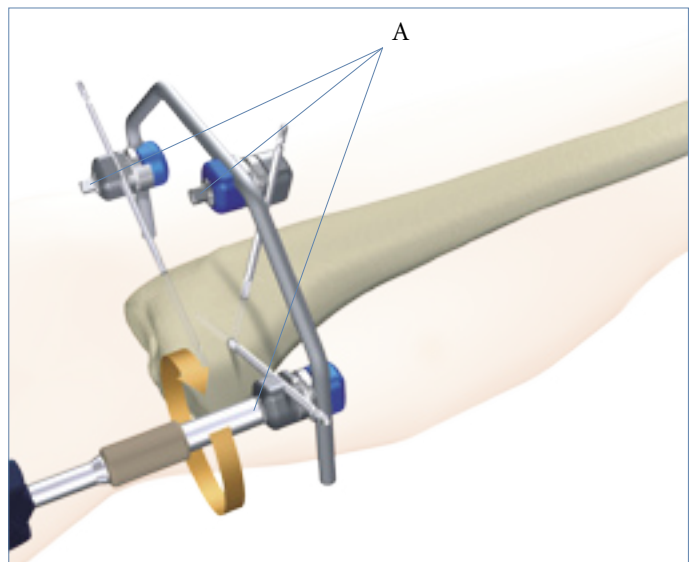

Step 5

At least 2cm distal to the fracture site, assemble a half-pin/pin clamp construct as shown here.

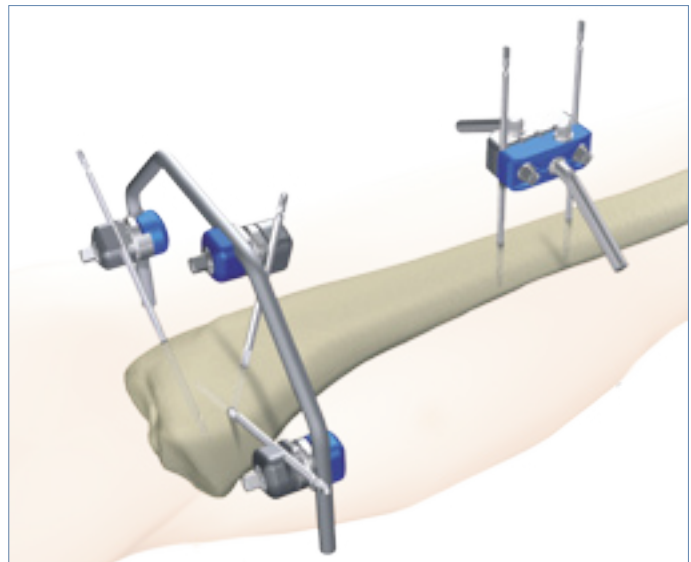

Operative Technique

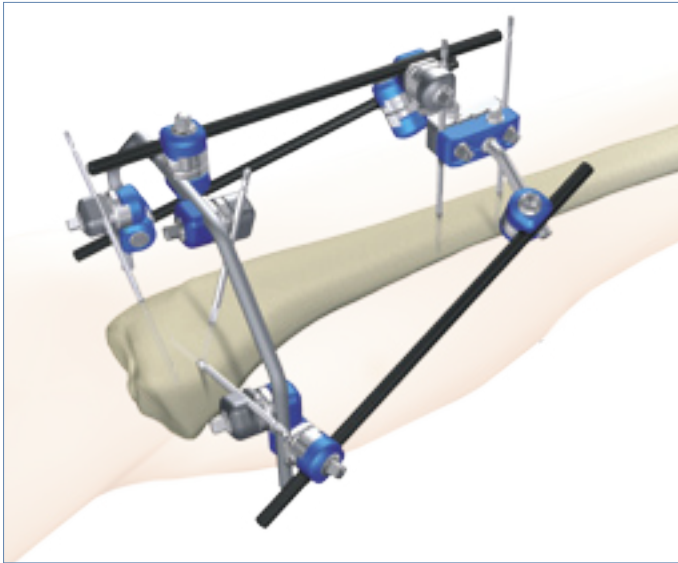

Tibia Plateau Fracture

Step 6

Connect the two constructs using 3 Connecting Rods, 5 Rod to Rod Couplings, and 1 Pin to Rod Coupling as shown here. Unrestricted multi-planar motion of the components allows for the manipulation of the fracture fragments with the fixator in place.

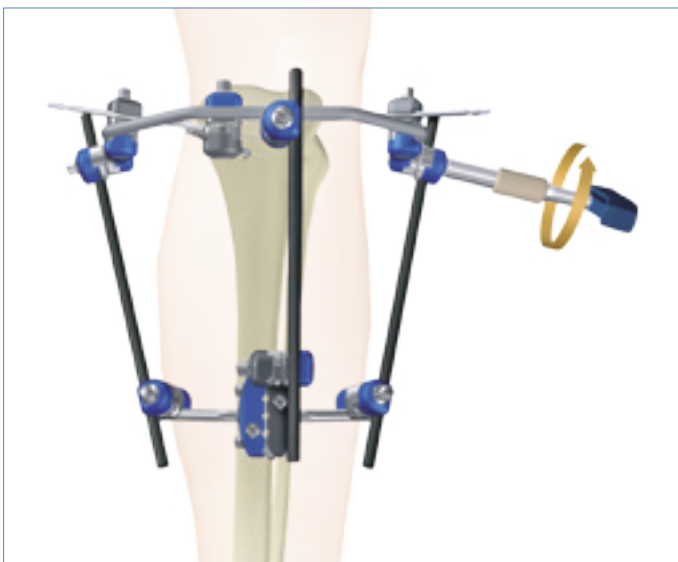

Step 7

After final adjustments and satisfactory alignment has been restored ensure that all Bolts are securely tightened. For proper alignment, check the final reduction with x-ray.

Note:

A half-pin may be added to the frame to capture a bone fragment or to further add stability.



Operative Technique

Ankle Stabilization Frame

Half-Pin Insertion Guidelines

The safe zone for the tibia and calcaneus is on the medial side. Take care not to damage soft tissue, particularly the posterior tibial artery or tibial nerve.

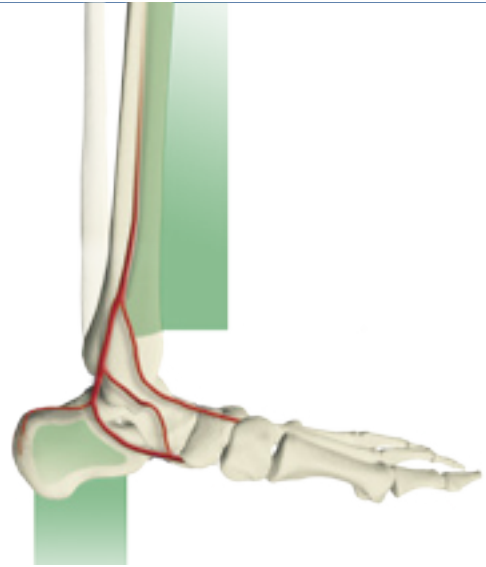

Step 1

Using soft-tissue protection, insert two half-pins medially into the calcaneus. Make sure to place the half-pins so that the completed frame is proximal to the base of the calcaneus.

Note:

Insert the half-pins in clamp-hole position 1 and 5 if the anatomy permits, since it will give the largest pin spread in the 5-Hole Pin Clamp providing maximum stability. Holes 3 or 4 are also suitable if the anatomy does not allow a hole-5 pin placement.

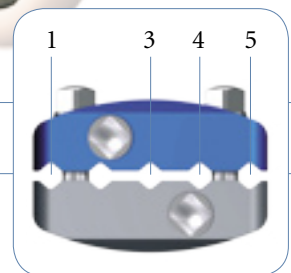
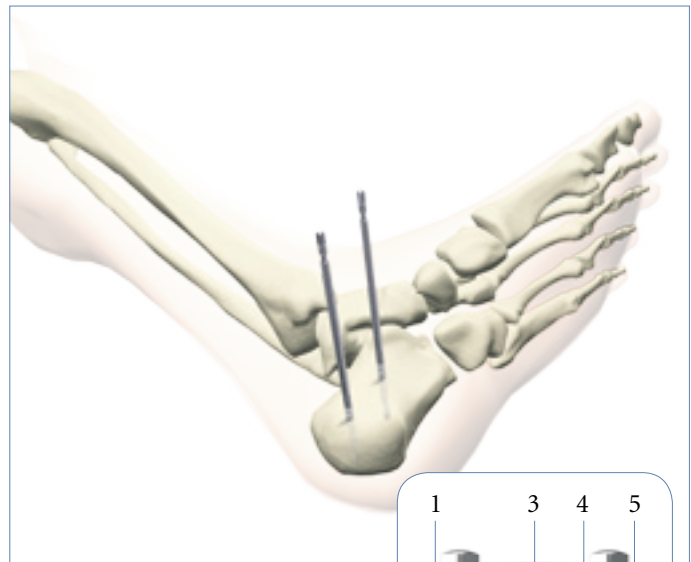

Step 2

Insert two half-pins into the diaphysis of the tibia. Insert the pins medio-anteriorly, approximately 15° to 20° anterior to the coronal plane.

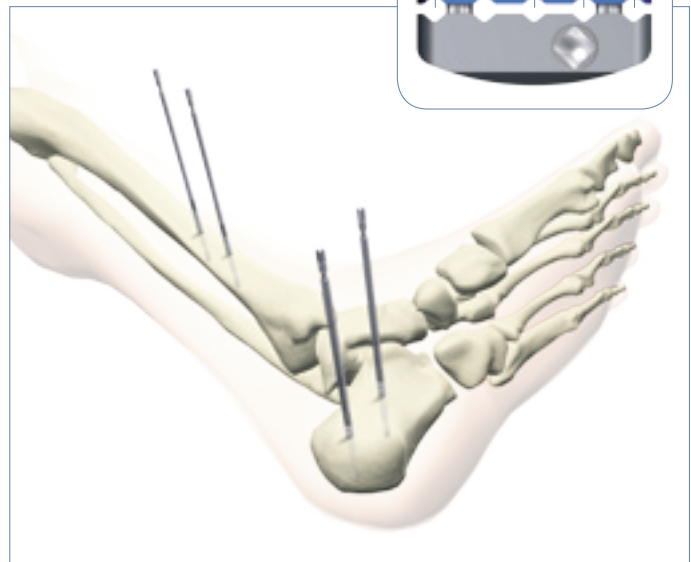

Operative Technique

Ankle Stabilization Frame

Step 3

Position two 5-Hole Pin Clamps approximately 1.5 to 2.0 centimeters away from the skin. Tighten Bolts A to secure the clamps to the half-pins.

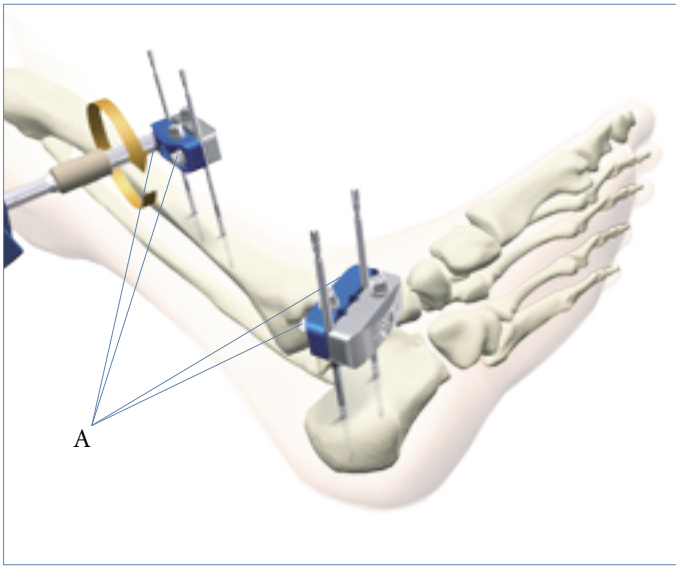

Step 4

Assemble a Hoffmann II® 30° Post to each of the 5-Hole Pin Clamps as illustrated. Tighten Bolts B to secure the posts.

Note:

Do not overtorque the Bolt B which does not contain a post.

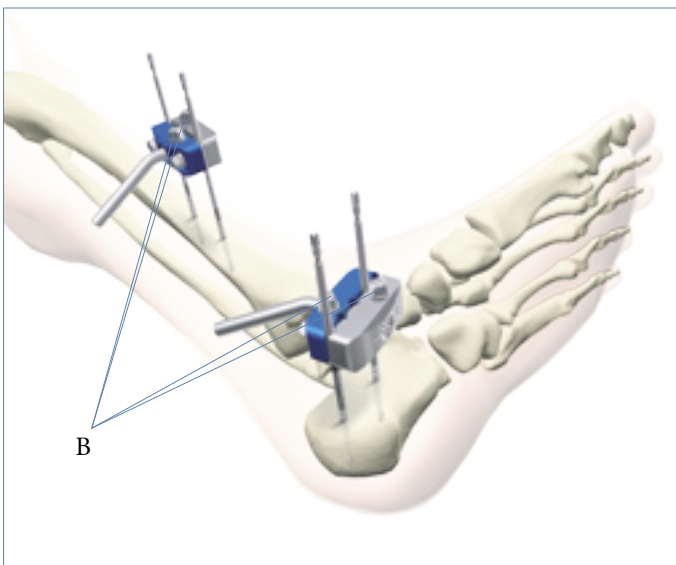

Step 5

Connect a Rod to Rod Coupling to each of the posts and a Pin to Rod Coupling to the distal tibial half-pin and the anterior calcaneal half-pin. Connect two ø8mm Connecting Rods to the couplings aligning the rods to the long axis of the tibia. This will connect the two 5-Hole Pin Clamps together.

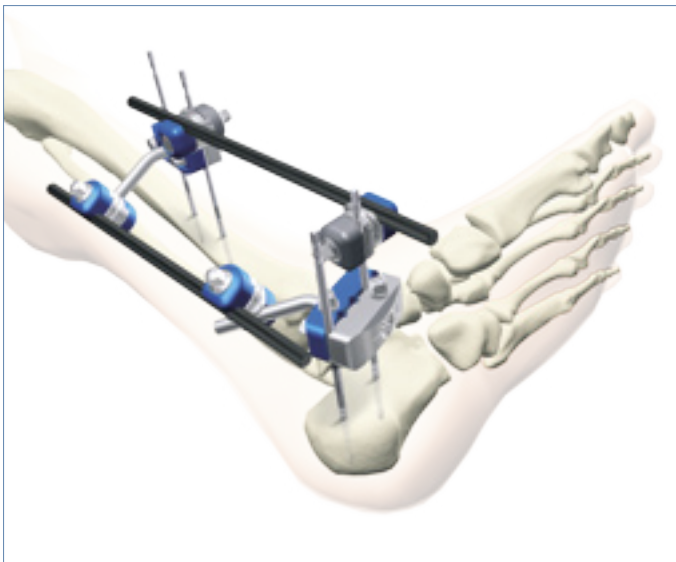

Operative Technique

Ankle Stabilization Frame

Step 6

After final adjustments and satisfactory alignment have been restored, tighten Bolts C on the Rod to Rod Couplings. Also, ensure that all of the bolts of the frame are securely tightened.

For proper alignment, check the final reduction with x-ray.

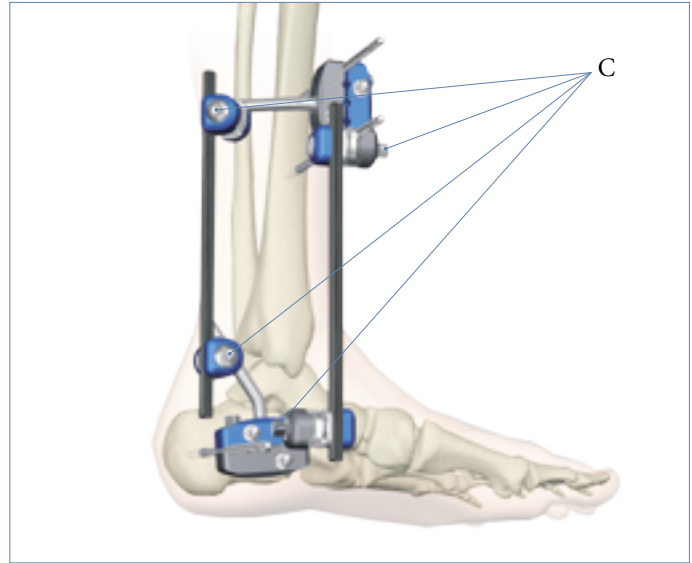

The construct shown here is an alternative ankle bridging frame. Two $\phi 5\text{mm}$ half-pins are placed in the tibia, one $\phi 5\text{mm}$ half-pin is placed in the calcaneus, and one $\phi 4\text{mm}$ half-pin is placed in the 1st metatarsal.

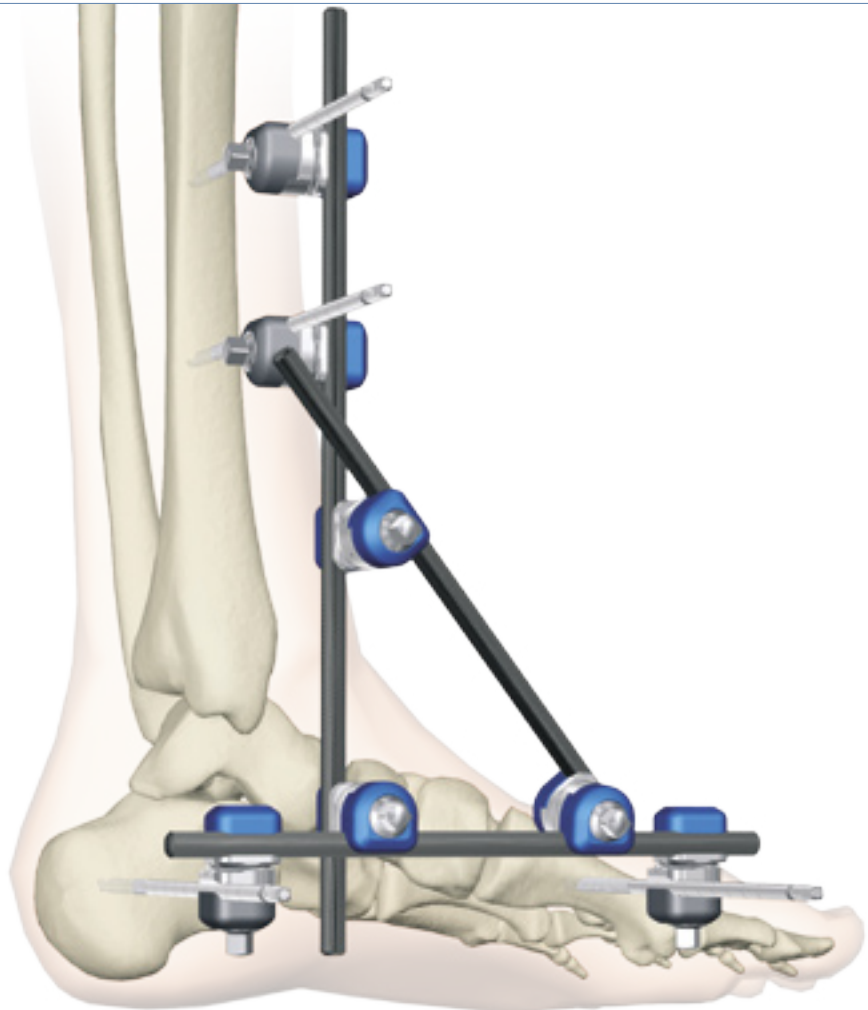

Operative Technique

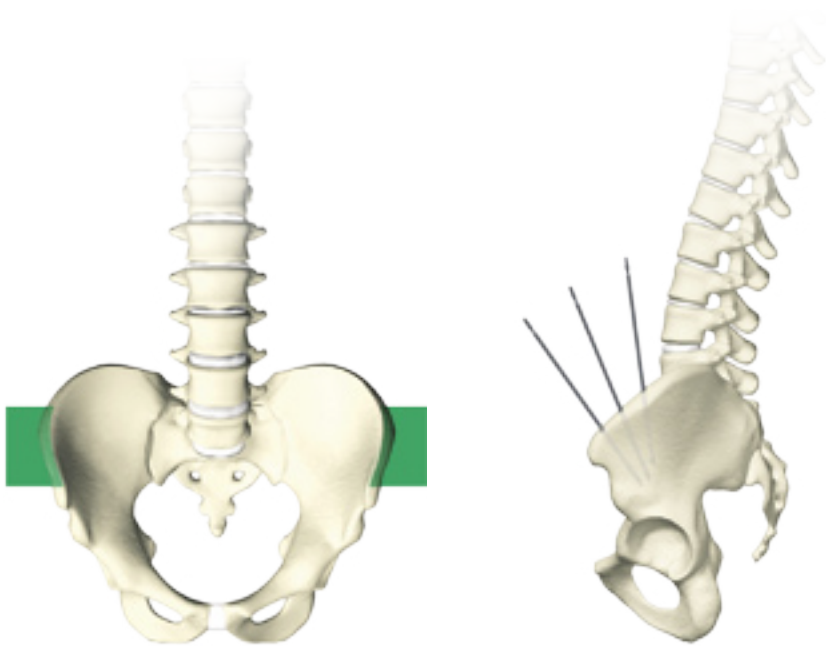

Pelvic Frame

Half-Pin Insertion Guidelines

The pelvic frame described in this technique uses three half-pins placed in each iliac crest. The first half-pin should be positioned 2.5cm posterior to the Anterior Superior Iliac Spine. The second and third half-pins should be inserted following the natural mid-line of the iliac crest with a distance of 1.5cm to 2.0cm between each of the pins.

Take care to insert the pins between the cortices of the iliac crest.

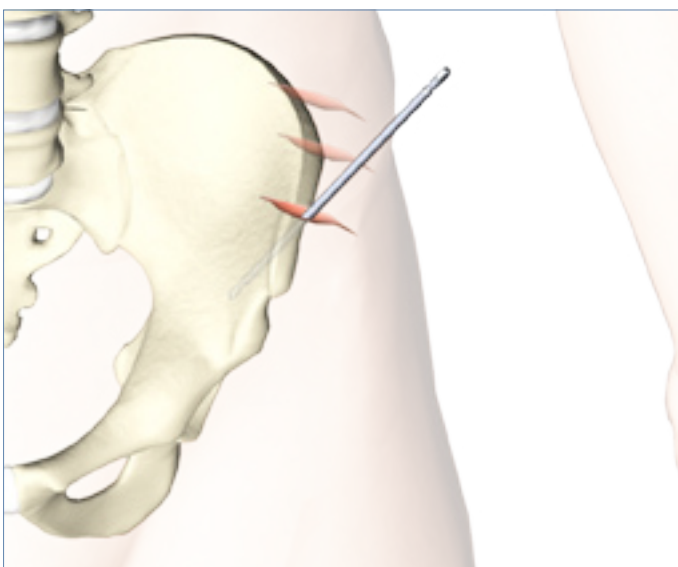

Step 1

Make a 1-2cm incision for each pin over the iliac crest toward the umbilicus. Blunt dissect to the bone after cutting through the skin.

Using soft-tissue protection, manually insert a half-pin between the inner and outer tables of the iliac crest toward the acetabulum. After initial penetration of the cortex, continue inserting the half-pin while taking care not to penetrate the inner or outer tables.

When using blunt pins, the outer cortex of the Iliac crest must be pre-drilled.

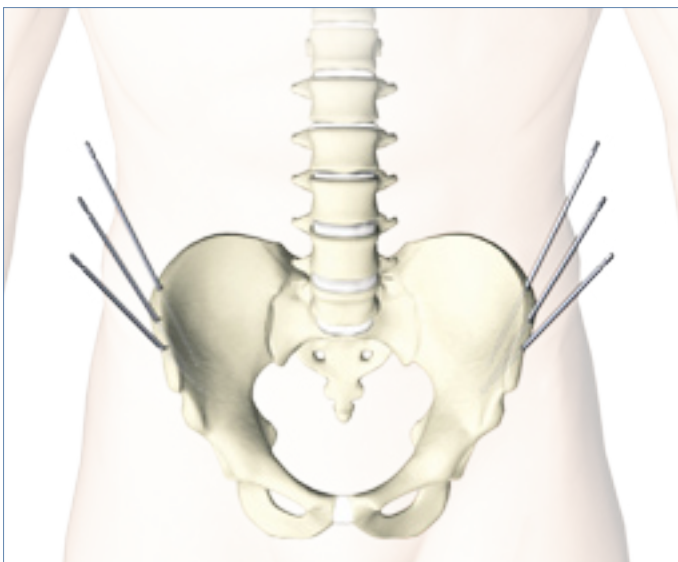

Step 2

Place the second and third half-pins in the same manner and check to ensure each has adequate purchase. Repeat steps 1 and 2 for the opposite side of the pelvis.

Operative Technique

Pelvic Frame

Step 3

Place a Pelvic Clamp over the three half-pins on each side of the pelvis. Tighten the clamps two to three finger-breadths away from the skin.

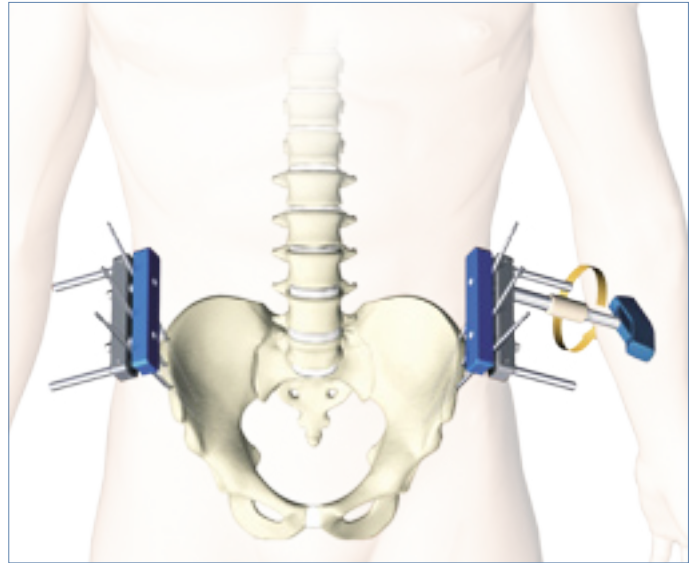

Step 4

Connect four Rod to Rod Couplings to the Pelvic Clamp Posts. From this base, build a "double cross bar" frame as shown here.

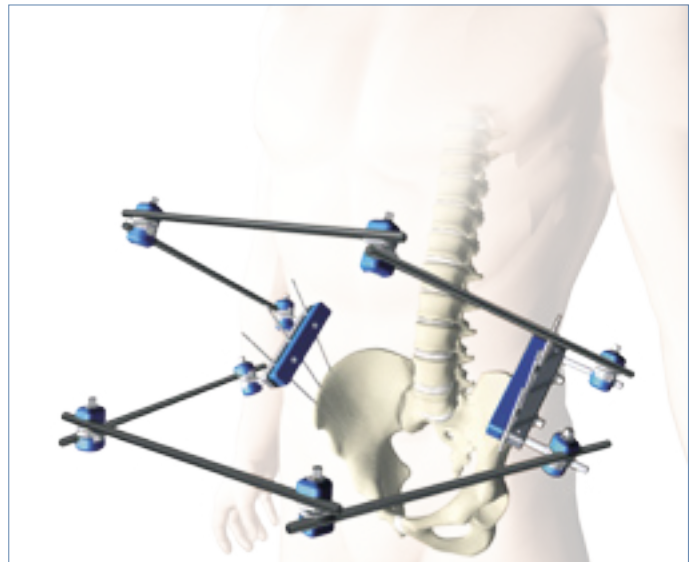

Step 5

While holding the reduced pelvis, properly adjust and stabilize the frame and fully tighten all bolts on the Pelvic Clamps and Rod to Rod Couplings.

To verify alignment, obtain an AP x-ray of the pelvis.

The Frame is complete.

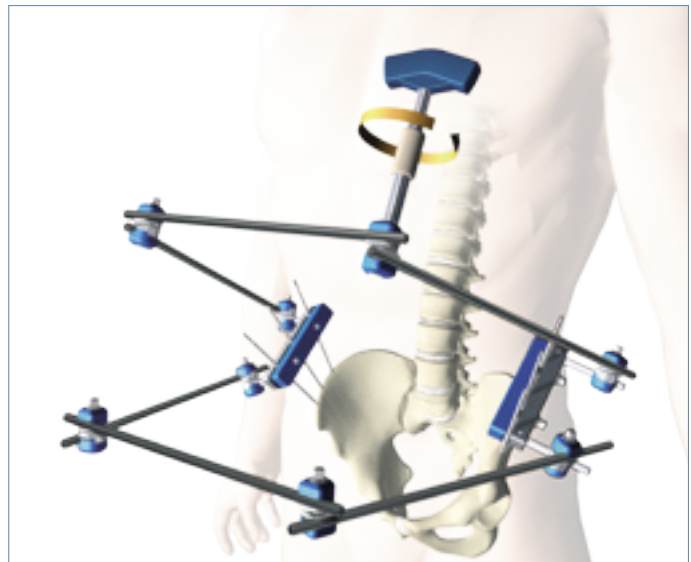

Operative Technique

Pelvic Frame

The construct shown below is an alternative pelvic frame. Two half-pins are placed in the supra-acetabular position on each side of the pelvis.

The half-pins should be inserted between the inferior and superior iliac spines with the first half-pin starting at the level of the anterior inferior iliac spine. This should be done in an open manner to avoid damage to neurovascular structures and under image intensifier control to check the pin positions. The direction of the pins is in the sagittal plane, and they should be angled slightly upwards (20 degrees) to avoid penetration of the acetabulum.







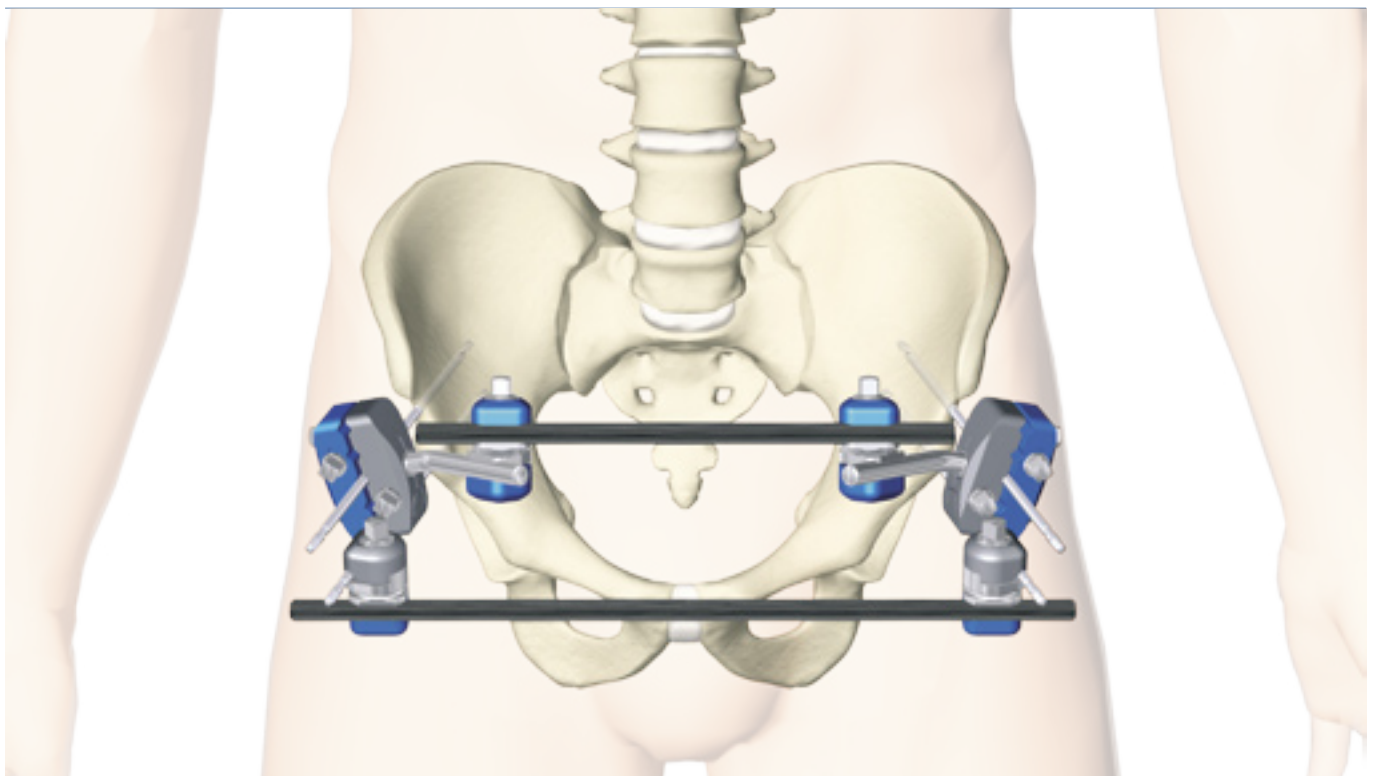
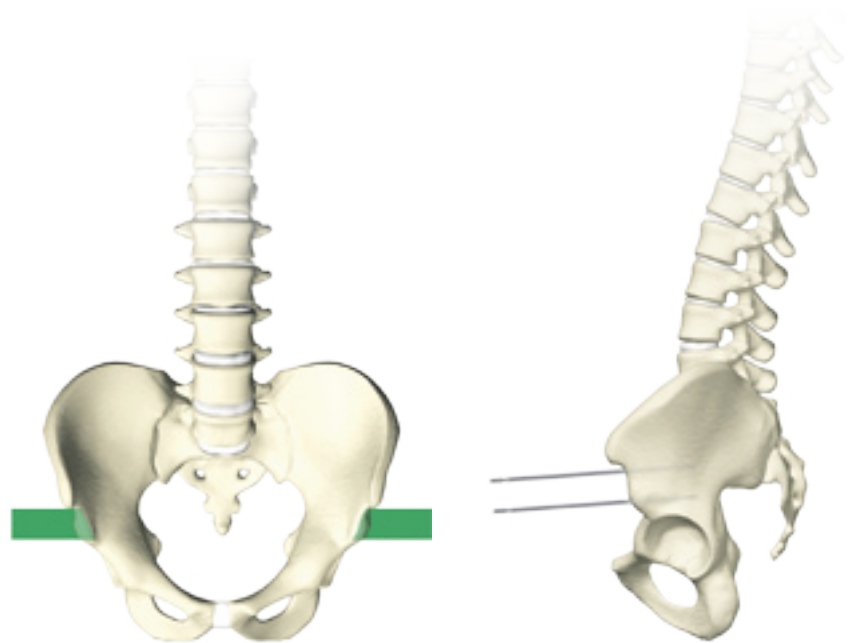

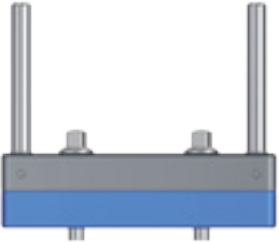

The second pin should be inserted proximal to the first one at a distance that corresponds to the 3rd to the 5th pin position in the 5-Hole Pin Clamp.

It is important to let the pins find their own way between the inner and outer tables of the ilium to obtain good fixation.



To verify alignment, obtain an X-Ray of the pelvis



Ordering Information - Components

	REF	Description	
Hoffmann II® Components			
	4920-2-020	5-Hole Pin Clamp	for Ø4, Ø5, and Ø6mm pins
	4920-2-060	10-Hole Pin Clamp	for Ø4, Ø5, and Ø6mm pins
	4920-2-080	Pelvic Clamp	for Ø4, Ø5, and Ø6mm pins
	4920-1-010	Rod to Rod Coupling	for Ø8mm rods or posts
	4920-1-020	Pin to Rod Coupling	for Ø4-5mm pins/Ø8mm rods or posts
	4920-1-030	Inverted Pin to Rod Coupling	for Ø8mm rods or posts/Ø4-5mm pins
	4920-1-100	Tube to Rod Coupling	for Ø20mm tubes/Ø8mm rods or posts
	4920-2-120	Straight Post	Ø8mm
	4920-2-140	30° Angled Post	Ø8mm
	4920-2-160	90° Angled Post	Ø8mm

Ordering Information - Components

	REF	Description	Length mm
Hoffmann II® Ø8mm Rods			
	5029-8-805	Carbon Connecting Rod	65
	5029-8-810	Carbon Connecting Rod	100
	5029-8-815	Carbon Connecting Rod	150
	5029-8-820	Carbon Connecting Rod	200
	5029-8-825	Carbon Connecting Rod	250
	5029-8-830	Carbon Connecting Rod	300
	5029-8-835	Carbon Connecting Rod	350
	5029-8-840	Carbon Connecting Rod	400
	5029-8-845	Carbon Connecting Rod	450
	5029-8-850	Carbon Connecting Rod	500
	5029-8-605	Aluminium Connecting Rod	65
	5029-8-610	Aluminium Connecting Rod	100
	5029-8-615	Aluminium Connecting Rod	150
	5029-8-620	Aluminium Connecting Rod	200
	5029-8-625	Aluminium Connecting Rod	250
	5029-8-630	Aluminium Connecting Rod	300
	5029-8-635	Aluminium Connecting Rod	350
	5029-8-640	Aluminium Connecting Rod	400
	5029-8-645	Aluminium Connecting Rod	450
	5029-8-650	Aluminium Connecting Rod	500
	5029-8-065	Stainless Steel Connecting Rod	65
	5029-8-100	Stainless Steel Connecting Rod	100
	5029-8-150	Stainless Steel Connecting Rod	150
	5029-8-200	Stainless Steel Connecting Rod	200
	5029-8-250	Stainless Steel Connecting Rod	250
	5029-8-300	Stainless Steel Connecting Rod	300
	5029-8-350	Stainless Steel Connecting Rod	350
	5029-8-400	Stainless Steel Connecting Rod	400
	5029-8-450	Stainless Steel Connecting Rod	450
	5029-8-500	Stainless Steel Connecting Rod	500

Ordering Information - Components

REF	Description	Length mm
-----	-------------	-----------

Hoffmann II® ø8mm Curved Rods and ø20mm Tubes

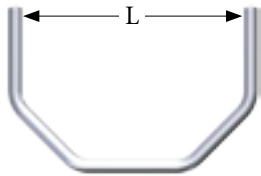

5029-7-028	Small Semi-Circular Curved Rod - Aluminium	134 (L)
5029-7-030	Medium Semi-Circular Curved Rod - Aluminium	174 (L)
5029-7-032	Large Semi-Circular Curved Rod - Aluminium	214 (L)



4920-0-000	Dynamization Tube
------------	-------------------



4920-0-015	Compression/Distraktion Tube
------------	------------------------------

Ordering Information - Instruments

	REF	Description
Hoffmann II® Instruments		
	4920-9-010	Stabilization/Reduction Wrench
	4920-9-020	Thumbwheel
	4920-9-030	7mm T-Wrench/5, 6mm Pin Inserter
	5054-8-009	7mm Spanner Wrench
	4920-9-986	Storage Case Lid
	4920-9-985	Storage Case Upper Insert
	4920-9-984	Storage Case Lower Insert
	4920-9-983	Storage Case Base

Notes

Notes

Joint Replacements

Trauma

Spine

Micro Implants

Orthobiologics

Instruments

Interventional Pain

Navigation

Endoscopy

Communications

Imaging

Patient Handling Equipment

EMS Equipment

Stryker Trauma AG
Bohnackerweg 1
CH-2545 Selzach
Switzerland

www.trauma.stryker.com

The information presented in this brochure is intended to demonstrate a Stryker product. Always refer to the package insert, product label and/or user instructions before using any Stryker product. Surgeons must always rely on their own clinical judgement when deciding which products and techniques to use with their patients. Products may not be available in all markets. Product availability is subject to the regulatory or medical practices that govern individual markets. Please contact your Stryker representative if you have questions about the availability of Stryker products in your area.

Products referenced with [™] designation are trademarks of Stryker.
Products referenced with [®] designation are registered trademarks of Stryker.

Literature Number: 5075-1-001
LOT B2205

Copyright © 2005 Stryker
Printed in Germany

